

# INSTALLATION INSTRUCTIONS

## 37325 / 37425 ( 1 - 4 ) SIDE BAR

### 2010 Dodge Ram 2500/3500 HD Crew Cab 6.4' Bed / 8' Bed

**Parts List:**

ITEM	QTY	DESCRIPTION	TORQUE MAX.
1	1	Side Bar Set	-
	1	<b>BRK-37625 Brackets kit includes:</b>	-
2	1	Front mounting brackets set	-
3	1	Front auxiliary mounting brackets set	-
4	2	Middle/Rear mounting brackets set	-
5	2	Rear auxiliary mounting brackets	-
6	6	"T" Plate	30 Lb.Ft
7	4	3/8" "T" Bolt	
	1	<b>KTE-37625 Hardware kit includes:</b>	
8	2	1/2 x 2" Hex head bolt zinc plated	75 Lb.Ft
9	2	1/2" Flat washer zinc plated	-
10	2	1/2" Lock washer zinc plated	-
11	24	3/8 x 1 1/4" hex head bolt zinc plated	30 Lb.Ft
12	34	3/8" lock washer zinc plated	-
13	34	3/8" flat washer zinc plated	-
14	14	3/8" hex nut zinc plated	30 Lb.Ft
15	10	Vynil gaskets	

**Required Tools (not included)**

DESCRIPTION	QTY
9/16" Socket / wrench	1
3/4" Socket / wrench	1
Ratchet	1
Ratchet extension	1

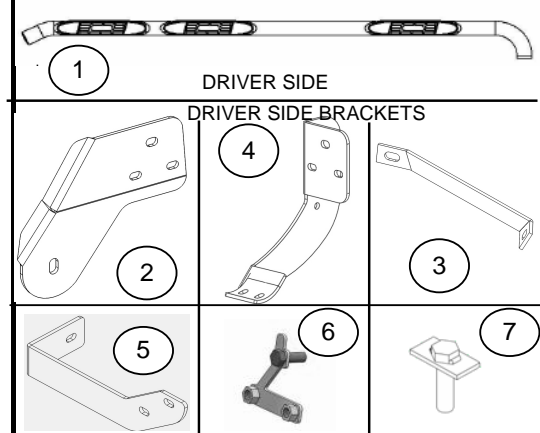

**Approximate installation time: 40 min.**

**Instructions:**

1. Before beginning the installation, please read all directions carefully and verify all necessary hardware is accounted for. If any parts are missing, stop the installation and contact your distributor immediately.

**DRIVER SIDE SHOWN**

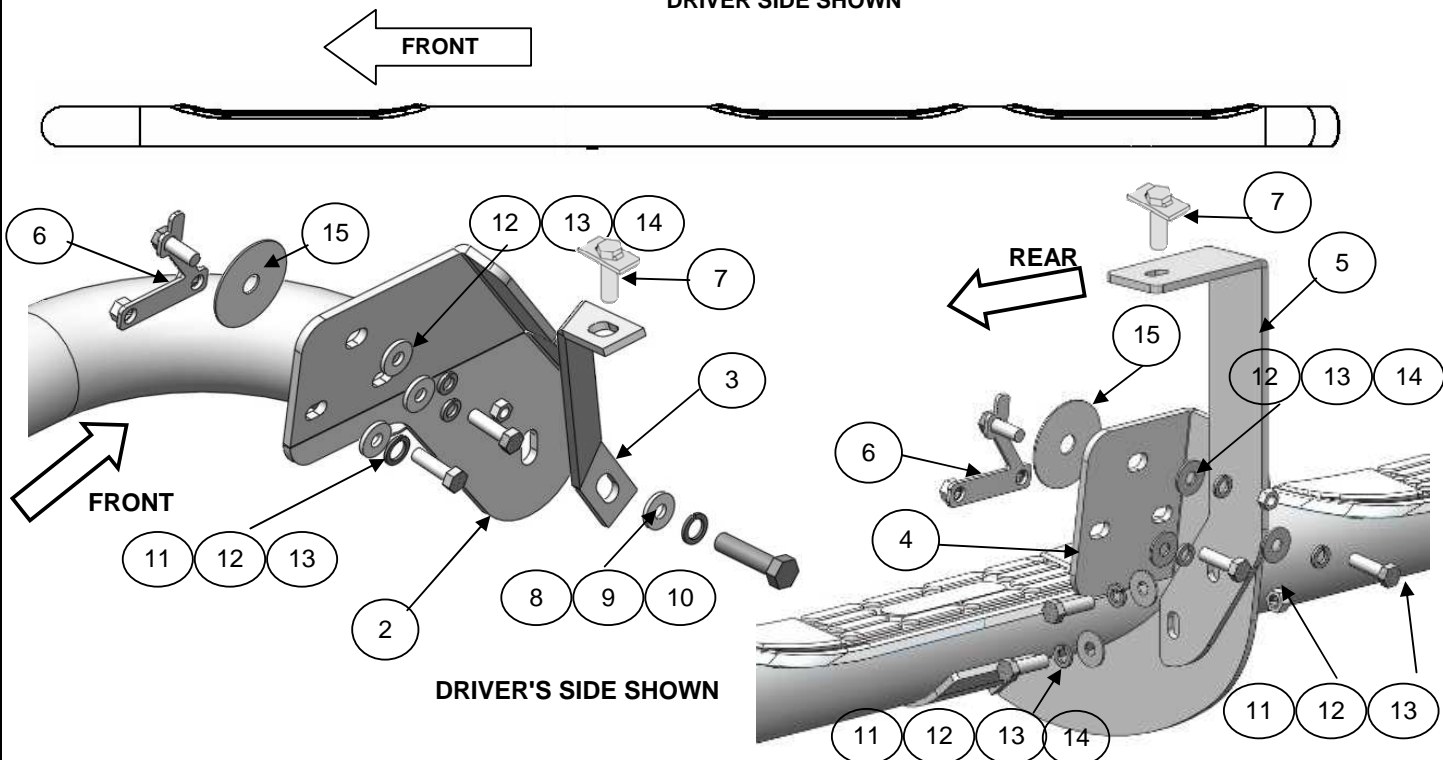

2. To install front, middle & rear mounting brackets locate in the rocker panel the holes covered in tape and remove the tape. Place (1) vinyl gasket to the bolt of the "T" plate then insert into the exposed hole. **See picture 1 & 4.** **NOTE:** It is important to place vinyl gaskets to the bolts to prevent the "T" plate from falling into the rocker panel.

**Cleaning and care instructions:**

Design:

Quality:

Keep your product clean. Do not use abrasive cleaners or polish. We recommend only non-abrasive automotive wax such as pure carnauba to avoid scratches or rust.

**INSTALLATION INSTRUCTIONS**  
**37325 / 37425 ( 1 - 4 ) SIDE BAR**  
**2010 Dodge Ram 2500/3500 HD Crew Cab 6.4' Bed / 8' Bed**

3. Place (1) front mounting bracket attach to the bolt of "T" plate previously placed using: (1) 3/8" flat and lock washers and 3/8" hex nut. Secure to the nuts of "T" plate using (2) 3/8 x 1 1/4" hex head bolt, (2) 3/8" flat and lock washers. See Picture 2. Leave loose. Repeat the procedure to install middle and rear mounting brackets.

4. To install auxiliary front mounting bracket, locate existing hole underside of the body then place (1) 3/8" "T" bolt with a vinyl gasket. Place auxiliary front mounting bracket and secure using (1) 3/8" flat and lock washers and (1) 3/8" hex nut. **See picture 3.** Leave loose.

**PICTURE 1**

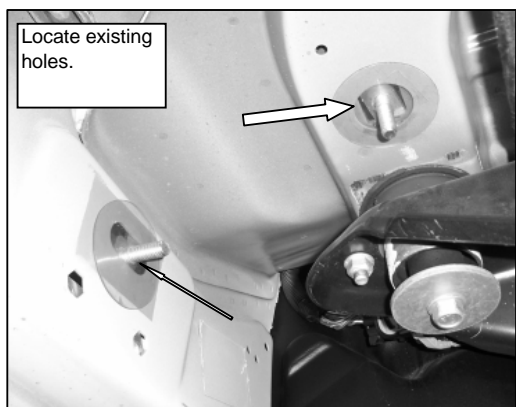

**PICTURE 2**

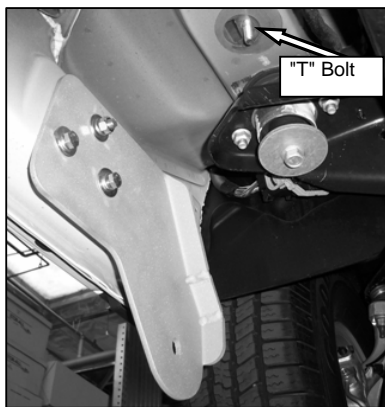

**PICTURE 3**

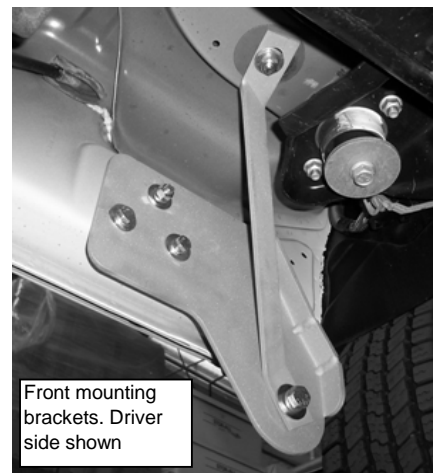

5. To install auxiliary rear mounting bracket, locate existing square hole in the underside of the body See Picture 4. Introduce (1) 3/8" "T" bolt with a vinyl gasket then place rear auxiliary mounting bracket and secure to the bolt previously placed using (1) 3/8" flat and lock washers and 3/8" hex nut. Secure the other end to the rear mounting bracket using (2) 3/8 x 1 1/4" hex head bolt, (2) 3/8" flat and lock washers and (2) 3/8" hex nut. Leave loose. Picture 5. **NOTE: Only rear mounting bracket has auxiliary bracket.**

6. Place side bar to the front mounting brackets and secure using (1) 1/2 x 2" hex head bolt, and (1) 1/2" flat and lock washers. **NOTE:** Using same 1/2" bolt secure front mounting bracket and auxiliary front mounting bracket to side bar. Leave loose. Use (2) 3/8 x 1 1/4" and 3/8" flat and lock washers to secure middle and rear mounting bracket. Leave loose.

**PICTURE 4**

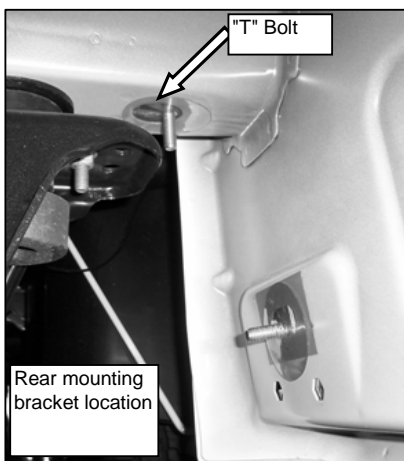

**PICTURE 5**

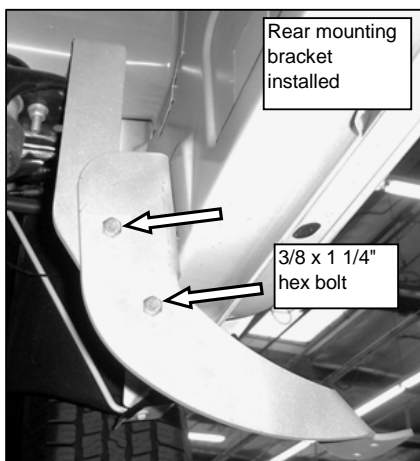

7. Align the sidebar to the vehicle and tighten all hardware.
8. Repeat for the other side of vehicle.
9. Fill out the warranty card included and place it inside your vehicle.

**Cleaning and care instructions:**

Design:

Quality:

Keep your product clean. Do not use abrasive cleaners or polish. We recommend only non-abrasive automotive wax such as pure carnauba to avoid scratches or rust.