

GO RHINO®

INSTALLATION INSTRUCTIONS



PART NO.

- D64052T
- D64052BS

PRODUCT DESCRIPTION:

- DOMINATOR D6 RUNNING BOARDS

APPLICATION:

- Chevrolet Silverado 1500, 2500HD & 3500HD Crew Cab
- GMC Sierra 1500 & 2500HD & 3500HD Crew Cab

PRODUCT SAFETY & LEGAL DISCLAIMER

- **IMPORTANT READ ALL INSTRUCTIONS CAREFULLY BEFORE INSTALLING, FAILURE TO DO SO MAY CAUSE PERSONAL INJURY OR DAMAGE TO PRODUCT AND/OR PROPERTY.**
- **Review the product package and contents prior to beginning the installation.** Take care when opening the packaging and removing items. If a return is needed you will want to return the product in its original packaging if possible.
- This instruction guide is provided as a GENERAL installation guide, some vehicles vary dimensionally and may require additional steps.
- Test fit the product on the vehicle prior to any third party modifications and or finishing. The manufacturer and/or distributors do not accept responsibility for third party charges, labor and or third part replacement modifications. Some modifications may void the factory warranty.
- Exercise due-diligence when installing this product. The manufacturer and distributors of this product do not accept any responsibility for vehicle damage or personal injury resulting from the installation of this product. Careless installation and operation can result in serious injury or equipment damage.
- This product is for general off-road use. All liability for installation and use rests with the owner/operator.
- **INSTALLER:** Once installation is complete, please return this guide along with other documentation included in this product back to the consumer for future reference. The manufacturer/distributors of this product do not guarantee this particular version will be available at a later date.

© 2016 Go Rhino Products. All rights reserved

www.gorhino.com

589 W. Apollo St., Brea, CA 92821

P: 888 427 4466



INSTALLATION INSTRUCTIONS

INJURY HAZARD

Please complete a shop and tool inspection prior to beginning the installation.

- Always make sure you have a clean, dry and well lit work area.
- Always remove jewelry, loose fitting clothing and wear protective gloves and eye protection.
- Always use extreme caution when jacking or raising a vehicle for work. Set the emergency brake and use tire/wheel blocks and jack stands. Refer to the vehicle manufacturer hand book. Utilize the vehicle manufacturers designated lifting points.
- Always use appropriate and adequate care in lifting parts during disassembly and installation. Seek help in lifting heavy or large items into place. Utilize jacks and or lifting devices when available.
- Always insure products are secure during disassembly and installation.
- Always wear eye protection and take steps to protect any exposed skin during the installations. Drilling, cutting and grinding plastic and metal may create flying particles that can cause injury.
- Always use extreme caution when drilling, cutting and or grinding on a vehicle. Thoroughly inspect the area to be drilled, on both sides of material, prior to modification and relocate any objects that may become damaged.
- Always assemble and tighten all fasteners per the installation instructions.
- Always route electrical cables carefully. Avoid moving parts, parts that may become hot and rough or sharp edges.
- Always insulate and protect all exposed wiring and electrical connections.

MAINTENANCE AND CARE

- Always perform regular inspections and maintenance on mounts and related fasteners.
- Periodically check and tighten all fasteners.
- Stripped, fractured, or bent fasteners must be replaced.
- After washing the vehicle make sure to fully dry all surfaces.
- In areas with cold temperatures make sure to wash the product often to remove harmful materials used on road ways.
- Never use abrasive cleaners or polish compounds. Clean with a gentle soap and water. If you use wax use a non-abrasive automotive wax such as pure carnauba wax.

WARNING

Some products have been designed to work together with factory rear sensor systems, factory forward facing sensor systems and factory air bags.

- Installation of some of these products may alter the factory sensor system performance.
- Factory sensors may read shackles or hooks protruding from the fairlead and or tow hooks.
- All sensor testing is completed by Go Rhino Products and or third party testing labs on modified vehicles.
- Sensor sensitivity, factory sensor housing, orientation, and operating conditions are all variables that will influence functionality of the sensors.
- Installation of some product may effect the factory air bag systems.
- Some products allow the use of third party products such as winches, shackles, hooks, etc. Follow the respective manufacturers operating instructions for use with our products.
- Make sure to fully understand the product, it's intended use and operation prior to use.
- Above all... be safe!

GO RHINO®

INSTALLATION INSTRUCTIONS

PARTS INCLUDED IN THIS LIST:

ITEM	QTY.	DESCRIPTION	ITEM	QTY.	DESCRIPTION
A	12	3/8"-16 x 1-1/4" Hex Bolt	G	4	M8-1.25 U-Nut
B	12	3/8" Lock Washer	H	6	M8-1.25 Hex Nut
C	12	3/8" Flat Washer	I	3	Driver Side Bracket
D	12	M8-1.25 x 25mm Hex Bolt	J	3	Passenger Side Bracket
E	12	5/16" Lock Washer	K	6	3/8" Nut-Plate (Included in Running Board)
F	18	5/16" Flat Washer	L	1	Dominator D6 Running Board Set (Not Shown)

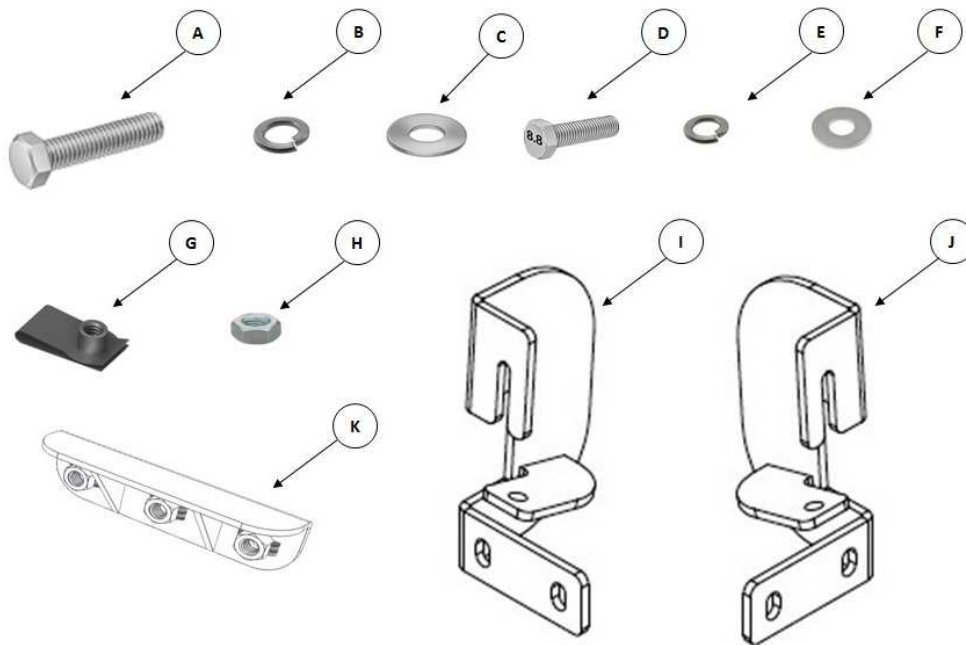

Go Rhino recommends you, the installer, read this installation instruction manual from front to back before installing the product. You may also [click here](#) to view an installation video or visit <http://www.gorhino.com/Installation-Videos>.

TOOLS NEEDED FOR INSTALLATION:

- 9/16", 13mm Socket & Wrench
- Tape Rule
- Ratchet & Extension

ESTIMATED TIME FOR INSTALLATION:

1 Hour

If you need installation service for your new product, call the authorized distributor from whom you purchased the product or an authorized installation service company which can be found by calling toll free 1-888-427-4466

GO RHINO®

INSTALLATION INSTRUCTIONS

1500 Models

Step-1 Beginning on the driver side, measure from the front fender bolt rearward approximately 14", (Photo 1) and locate the M8 nut welded to the body pinch mold and the M8 threaded insert in the rocker panel, (Photo 2).

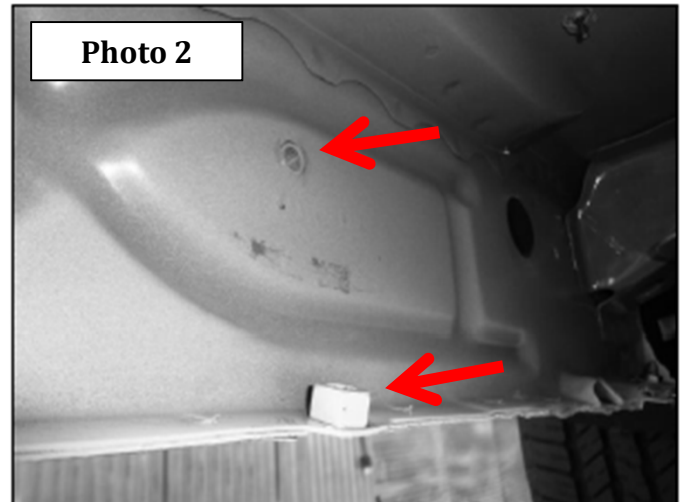
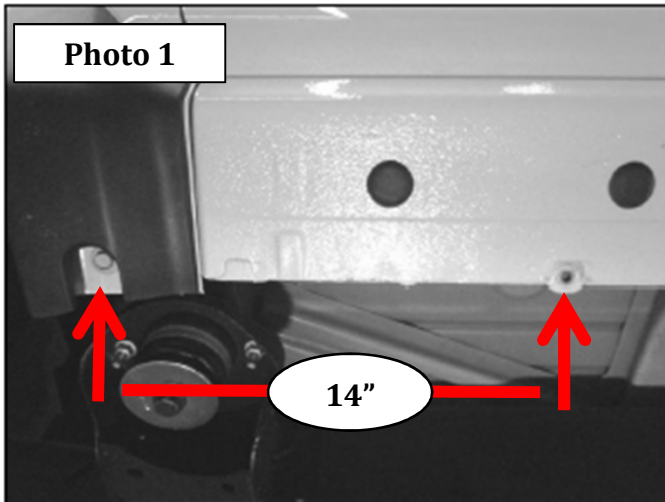

Step-2 Attach one of the driver side brackets to the pinch mold using (1) M8 hex bolt, (1) 5/16" lock washer and (1) 5/16" lock washer, and to the rocker panel using (1) M8 hex bolt, (1) 5/16" lock washer and (1) 5/16" flat washer. Leave the bolts loose for final adjustment, (Photo 3).

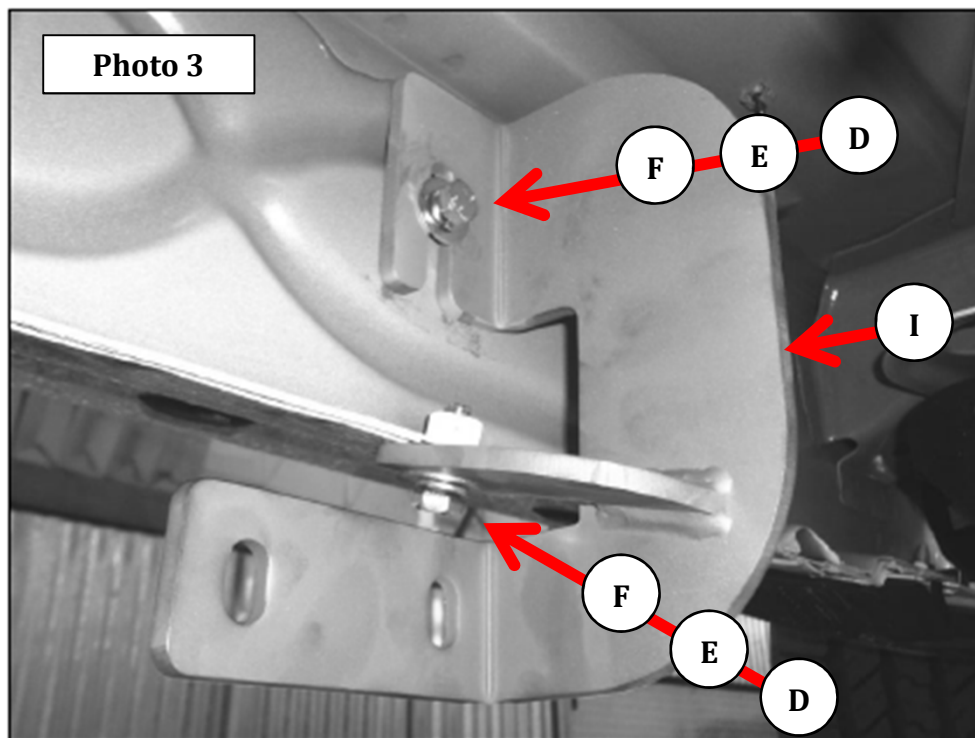

GO RHINO®

INSTALLATION INSTRUCTIONS

1500, 2500HD & 3500HD Models

Step-1 Measure from the front fender bolt rearward approximately 14" and locate the hole in the body pinch mold and the M8 threaded insert in the rocker panel, (Photo 4).

Step-2 Attach one of the driver side brackets to the pinch mold using (1) M8 hex bolt, (2) 5/16" flat washers, (1) 5/16" lock washer and (1) M8 hex nut, and to the rocker panel using (1) M8 hex bolt, (1) 5/16" lock washer and (1) 5/16" flat washer. Leave the nut and bolts loose for final adjustment, (Photo 5).

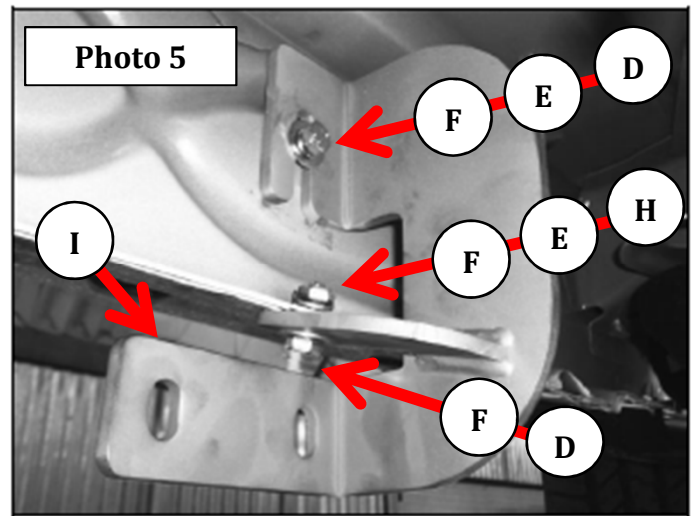
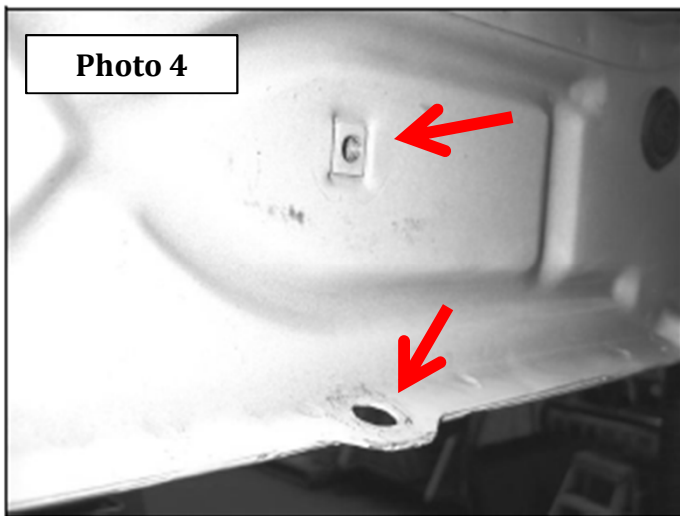

All Models

Step-3 Install the driver side center bracket by measuring from the front fender bolt rearward approximately 58 7/8" and locate the hole in the body pinch mold and the plastic plug in the rocker panel, (Photo 6). Remove the plastic plug from the rocker panel and install (1) M8 U-Nut in the rocker panel, (Photo 7).

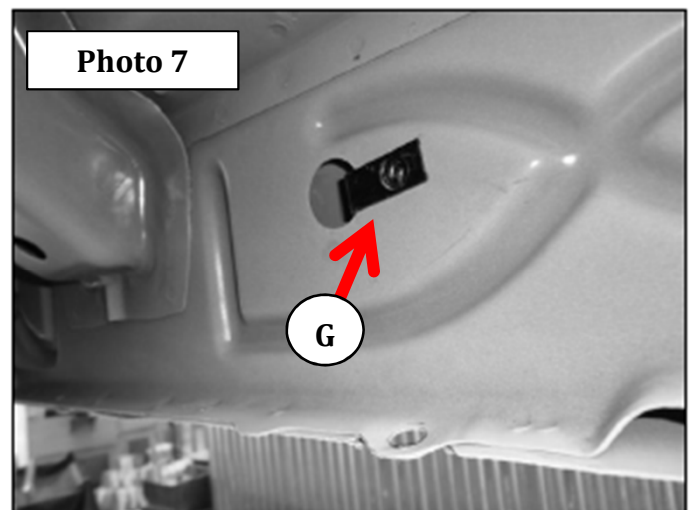
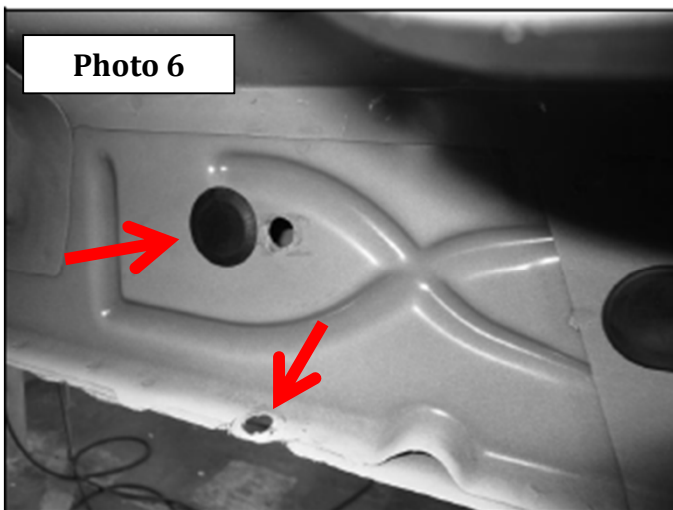



INSTALLATION INSTRUCTIONS

Step-4 Attach one of the driver side brackets to the rocker panel using the U-Nut, (1) M8 hex bolt, (1) 5/16" lock washer and (1) 5/16" flat washer, and to the pinch mold using (1) M8 hex bolt, (2) 5/16" flat washers, (1) 5/16" lock washer, and (1) M8 hex nut. Leave the nut and bolts loose for final adjustment, (Photo 8).

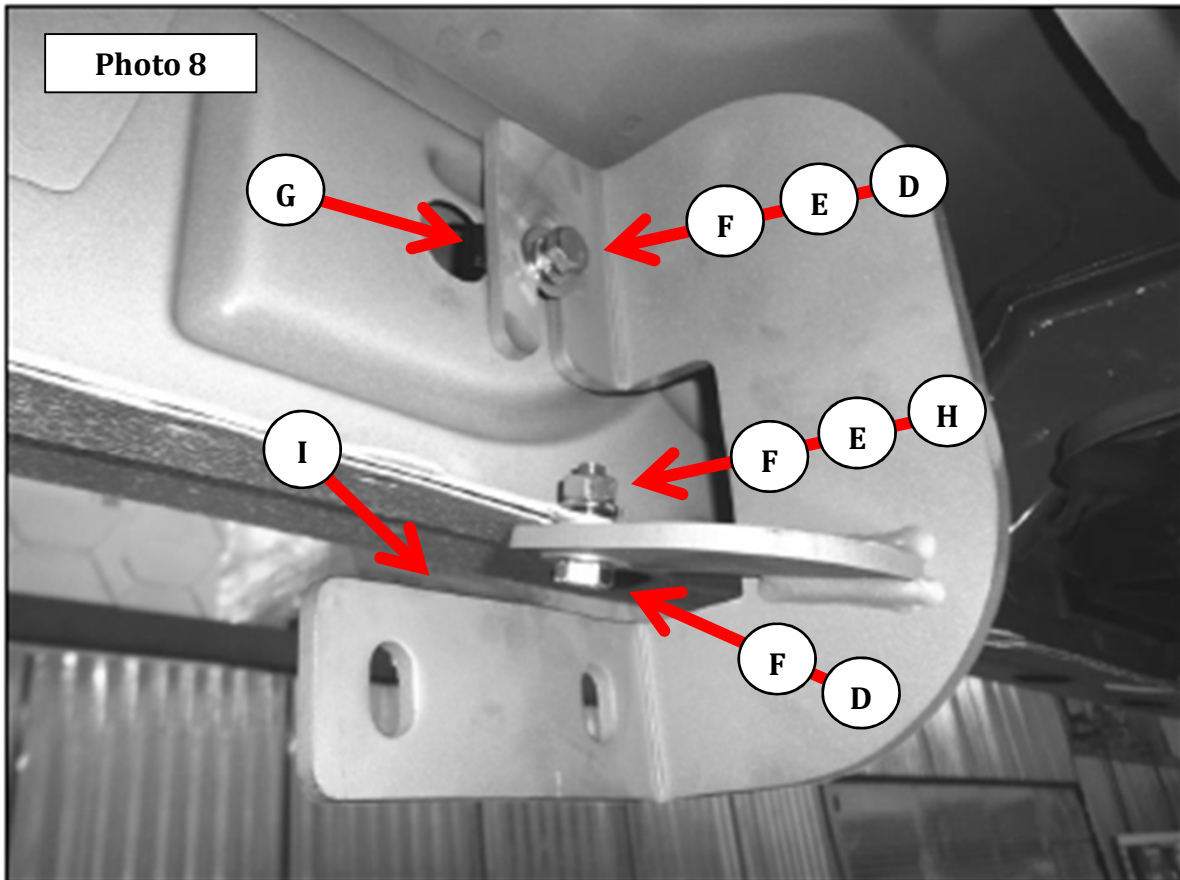

Step-5 Install the driver side rear bracket by measuring from the front fender bolt reward approximately 75 1/8" and repeat the above steps.

GORRHINO®

INSTALLATION INSTRUCTIONS

Step-4 Insert three of the Nut-Plates through the rectangular opening in the back of the Dominator D6 running board. Measure and position each Nut-Plate so it aligns with one of the three mounting brackets previously attached to the vehicle, (Photo 9).

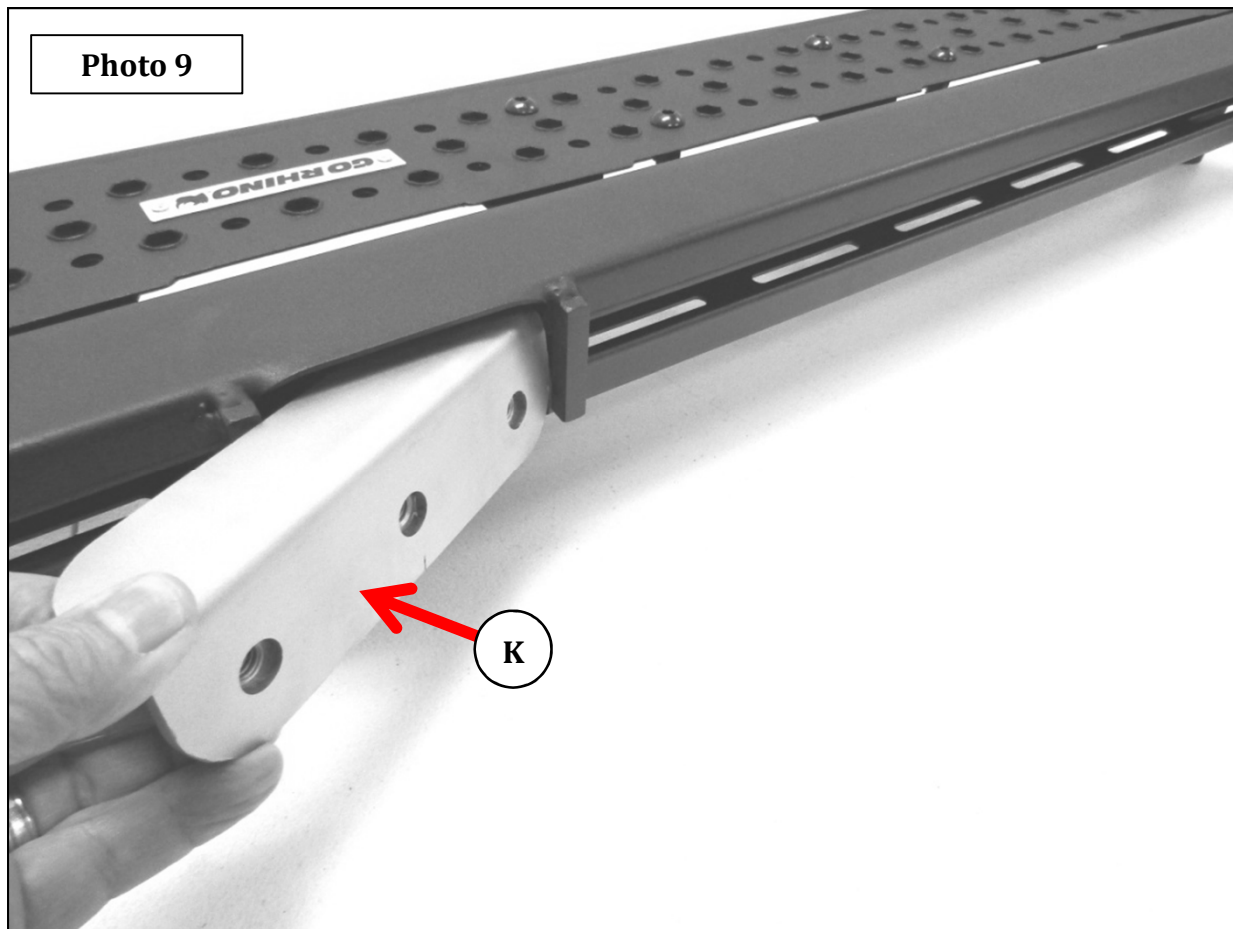

GO RHINO®

INSTALLATION INSTRUCTIONS

Step-4 Attach the driver side running board to each bracket using (2) 3/8" x 1 1/4" hex bolts, (2) 3/8" lock washers, (2) 3/8" flat washers, and (1) Nut -Plate (Photo 10).

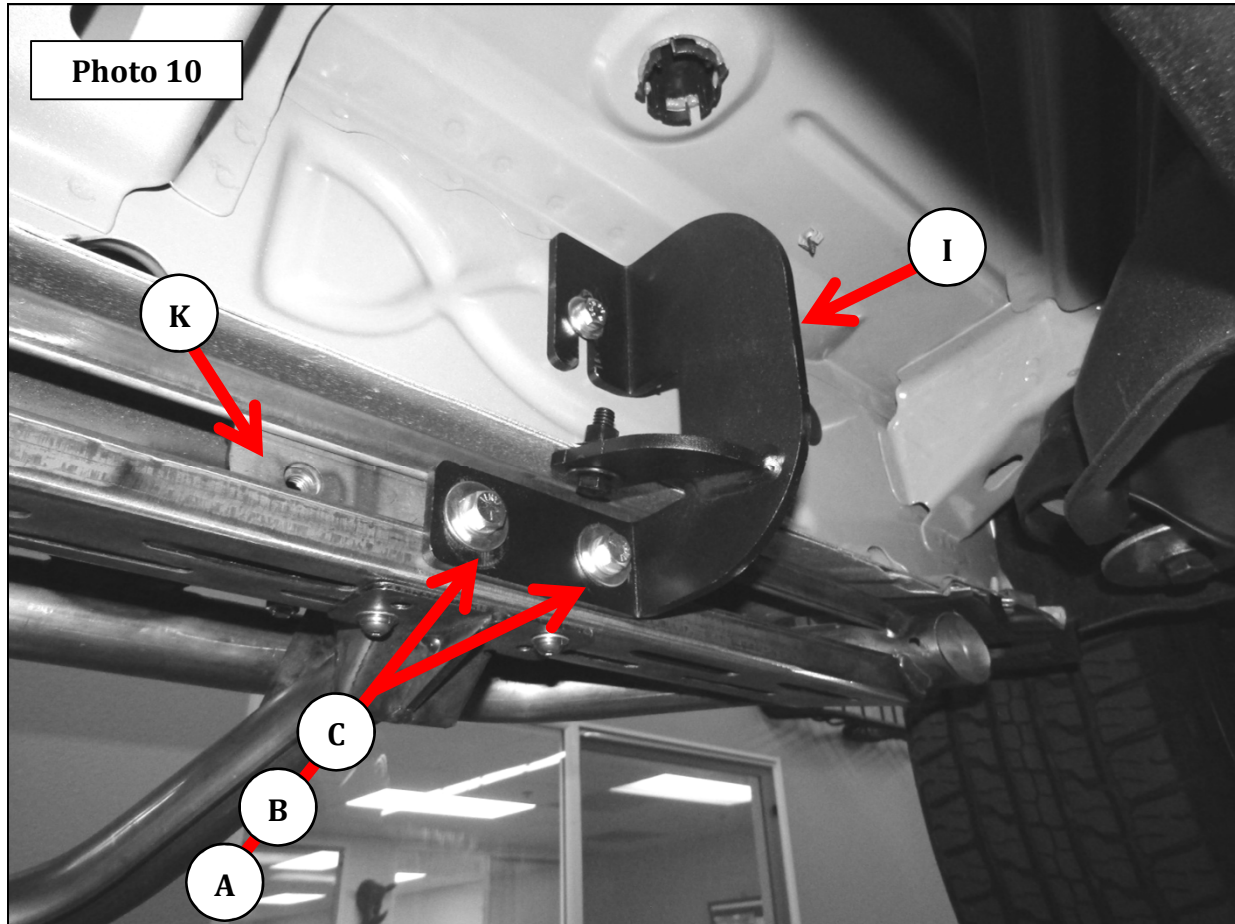

Step-5 Align the running board with the vehicle and tighten all bracket and side step nuts and bolts,. Repeat the above steps to install the passenger side brackets and running board. Remember to check and retighten the nuts and bolts every six months.



INSTALLATION INSTRUCTIONS

LIMITED WARRANTY

Go Rhino warrants to Buyer that for a period of five (5) years from the date of shipment of the product(s) ("Warranty Period") for black finishes and chrome finishes, that such products will materially conform to the specifications set forth in Go Rhino's specifications in effect as of the date of shipment(s) and will be free from material defects in material workmanship.

Go Rhino warrants to Buyer that for the life of the product(s) from the date of shipment of the product(s) ("Warranty Period") for polished stainless steel finished products purchased after April 2004, that such products will materially conform to the specifications set forth in Go Rhino's specifications in effect as of the date of shipments and will be free from material defects in material workmanship.

Warranty claims must be accompanied with the original invoice and photos of the product. It is the customer's responsibility to clean regularly and protect finish with regular applications of a nonabrasive polish that is compatible with the product's finish.

This warranty covers the cost of the product only and does not include the cost of removal, installation, third party modifications or shipping of the product. In no event shall Go Rhino be liable to buyer or any third party for any damage or harm caused by the product or use thereof, regardless of weather such damages were foreseeable and whether or not Go Rhino has been advised of the possibility of such damages, not withstanding the failure of any agreed or other remedy of its essential purpose. This warranty is void if the product shows signs of alteration, misuse, mishandling, improper care, neglect, improper application and/or damage due to improper installation.

With respect to any such product(s) during the limited warranty period, Go Rhino shall, in its sole discretion, either: (i) provide a one-time repair or replacement of such products (or the defective part) or (ii) credit or refund the price of such products at the pro rata contract rate provided that, if Go Rhino so requests, Buyer shall, at Go Rhino's expense, return such product(s) to Go Rhino. The remedies shall be the Buyer's sole and exclusive remedy and Go Rhino's entire liability for any breach of the limited warrant(ies).

Go Rhino disclaims all other warranties except to the extent that any such warranty cannot be validly disclaimed under applicable law.

Finish Limited Warranty:

Limited lifetime on stainless steel products (after April 2004)

5 year warranty on black powder coat products

5 year warranty on chrome products

This warranty does not cover exposed welds

Finish warranty covers peeling, flaking, or cracking. Washing all finishes regularly with car wash soap and rinsing well with water is the best method for maintaining the finish on your products. You must also protect the finish with nonabrasive automotive wax on a regular basis. The use of any compound which contains abrasives becomes a self-defeating exercise as the compound scratches the finish and opens it to corrosion. The use of harsh chemicals used to remove bugs and tar may also cause the finish to fail and should be avoided.

If you are unsatisfied with your purchase please contact the establishment you purchased the product from.

If you need to place a warranty claim or need assistance, the Go Rhino customer service team will answer any questions you may have. Please contact the Go Rhino customer service team at 1-888-427-4466 during normal business hours Monday thru Friday 7 am to 5 pm PST. You may also email warranty@gorhino.com. In order to better serve you please provide a copy of the original invoice / receipt, a photo of the issue you are experiencing and a photo of the vehicle the product is installed on.

All warranty returns must have an approved RGA number. The RGA number must be clearly marked on the exterior of the return package. All approved warranty returns must be shipped to Go Rhino Products, 1002 Carriers Drive, Laredo, Texas 78045.

PRODUCT REGISTRATION

Please remember to register your new purchase. You may register your product at www.gorhino.com. Registering your product may help speed any future warranty or customer service inquiries.

Thank you again for purchasing from Go Rhino Products

Please take a few minutes to view additional products for your vehicle and more at GORHINO.com
These installation instructions are available on the Go Rhino web site along with installation videos for many of our products.

www.gorhino.com

www.bigcountryauto.com

www.gorhinopd.com