

INSTALLATION INSTRUCTIONS

3000 SERIES STEP GUARD (CENTER GRILLE GUARD ONLY)
TOYOTA TACOMA 2/4WD
PART # 3819 (B-C)



<u>QTY</u>	<u>PARTS DESCRIPTION</u>
8	3/8" X 1" BUTTON HEAD BOLTS
2	3/8" X 1" HEX BOLTS
2	3/8" X 1 1/4" HEX BOLTS
2	3/8" X 4 1/2" HEX BOLTS
4	3/8" FLAT WASHERS
2	3/8" HOLE 1/4" THICK WASHERS
10	3/8" LOCK WASHERS
8	3/8" HEX NUTS
6	1/2" X 1 1/2" HEX BOLTS
8	1/2" FLAT WASHERS
6	1/2" LOCK WASHERS
6	1/2" HEX NUTS

<u>QTY</u>	<u>PARTS DESCRIPTION</u>
1	TT3819 TOP TUBE
1	CP3005 CENTER PLATE
1	ST3005 STEP TUBE
1	3819D DRIVER SIDE PLATE
1	3819P PASSENGER SIDE PLATE
1	14952D DRIVER UPPER BRACKET
1	14952P PASSENGER UPPER BRACKET
1	14950D DRIVER LOWER BRACKET
1	14950P PASSENGER LOWER BRACKET

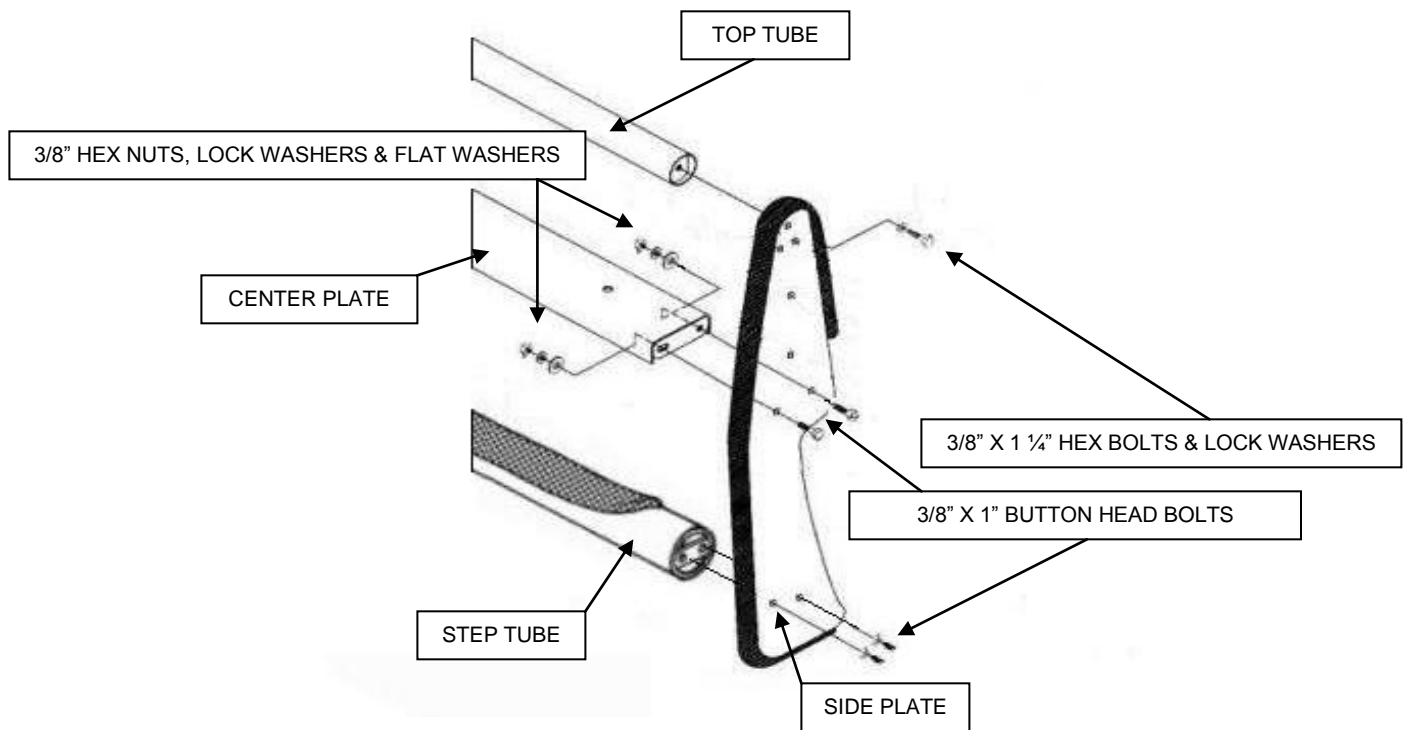

ASSEMBLY

READ THE ASSEMBLY AND INSTALLATION INSTRUCTIONS COMPLETELY BEFORE YOU BEGIN.

STEP-1 BEGIN THE ASSEMBLY BY LAYING THE COMPONENTS OUT ON A PROTECTIVE SURFACE.

STEP-2 POSITION THE STEP TUBE, CENTER PLATE AND TOP TUBE BETWEEN THE GRILLE GUARD SIDE PLATES.

STEP-3 LOOSELY ATTACH THE STEP TUBE TO THE SIDE PLATES USING THE 3/8" X 1" BUTTON HEAD BOLTS. THE CENTER PLATE USING THE 3/8" X 1" BUTTON HEAD BOLTS, WASHERS, AND NUTS, AND THE TOP TUBE USING THE 3/8" X 1 1/4" HEX BOLTS, AND LOCK WASHERS.

STEP-4 ALIGN THE GRILLE GUARD ASSEMBLY, AND TIGHTEN ALL NUTS AND BOLTS.

INSTALLATION INSTRUCTIONS

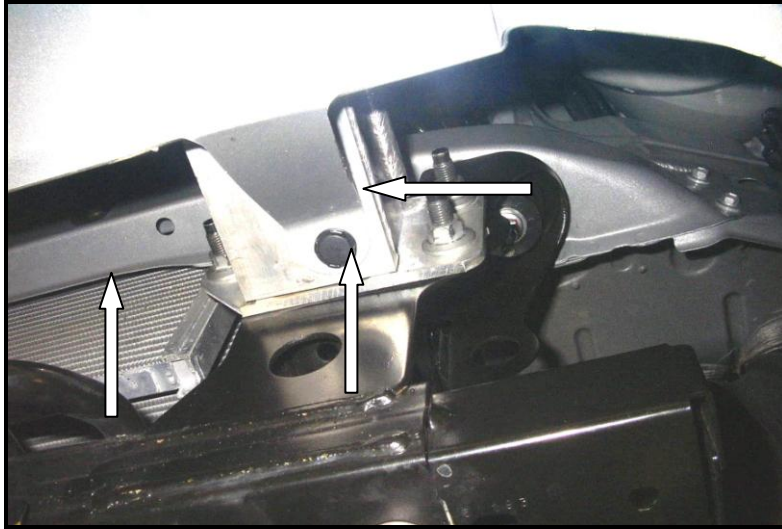

STEP -1 BEGINNING WITH THE DRIVER SIDE, LOCATE THE STUDS AND HEX NUTS THAT SECURE THE BUMPER BRACKET TO THE FRAME. REMOVE (3) HEX NUTS AT THE LOCATIONS SHOWN.

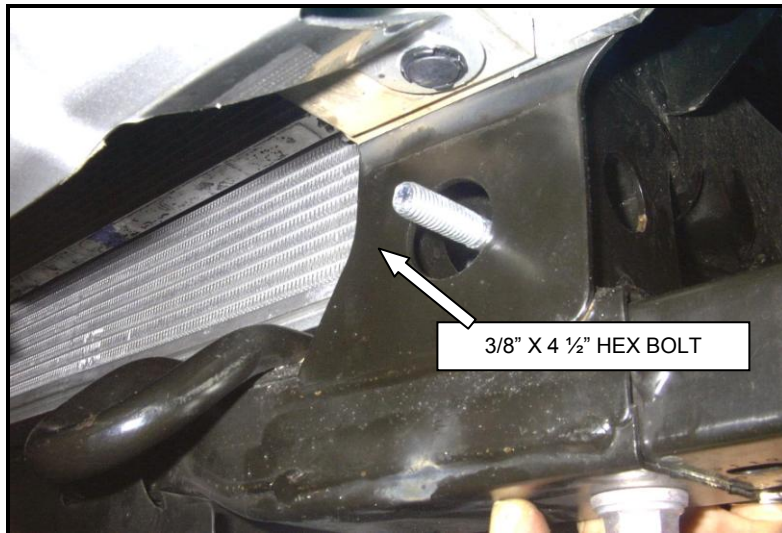

STEP -2 SLIDE THE 1/4" THICK WASHER OVER 3/8" X 4 1/2" HEX BOLT. INSERT THE BOLT THROUGH THE HOLES IN THE BOXED FRAME SECTION WITH THE THREADS EXTENDING OUTWARD AS SHOWN.

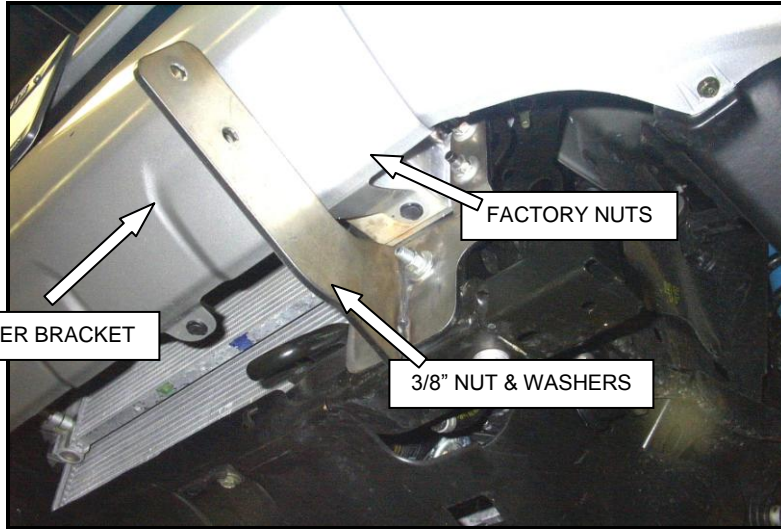

STEP -3 POSITION 14950D LOWER MOUNTING BRACKET OVER THE STUDS, AND 3/8" HEX BOLT. LOOSELY ATTACH THE BRACKET TO THE FRAME USING THE FACTORY NUTS, 3/8" HEX NUT AND WASHER AS SHOWN. REPEAT THE ABOVE FOR THE PASSENGER SIDE LOWER MOUNTING BRACKET.

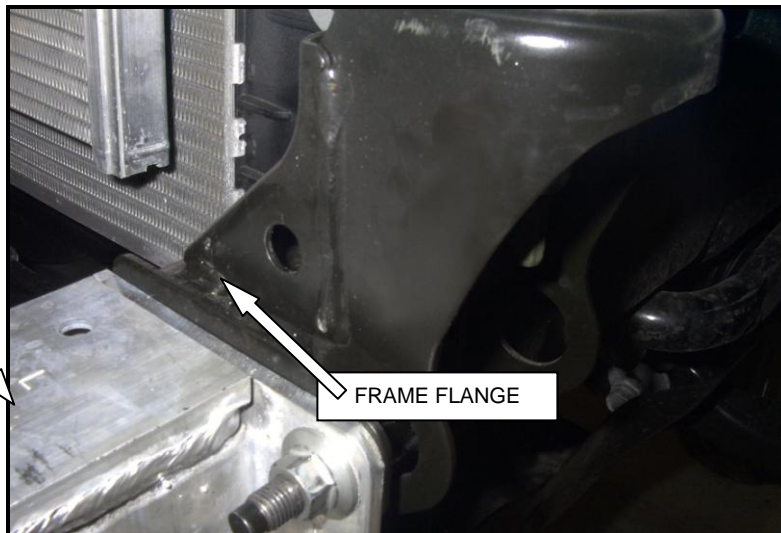

STEP- 4 LOCATE THE HOLE IN THE FRAME FLANGE ABOVE THE BUMPER BRACKET.

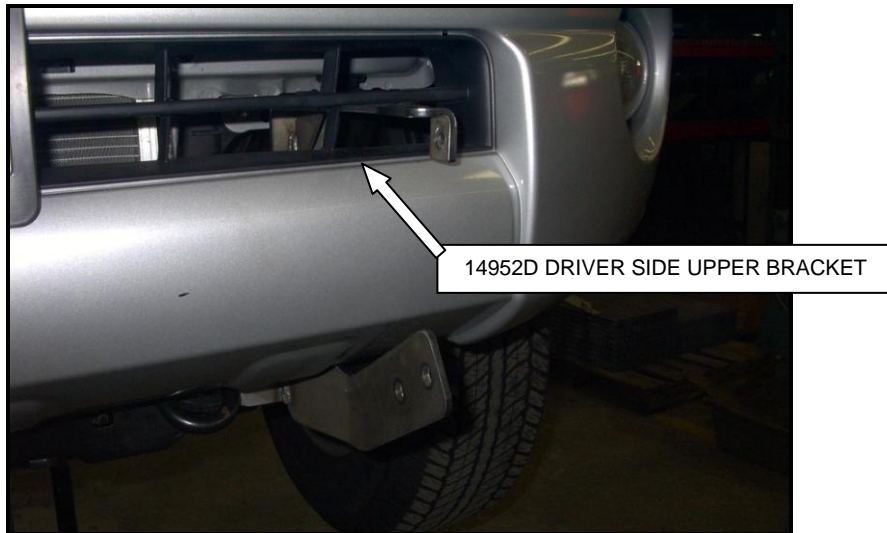

STEP- 5 POSITION 14952D UPPER BRACKET BEHIND THE BUMPER, AND OUT THROUGH THE GRILLE OPENING AS SHOWN.

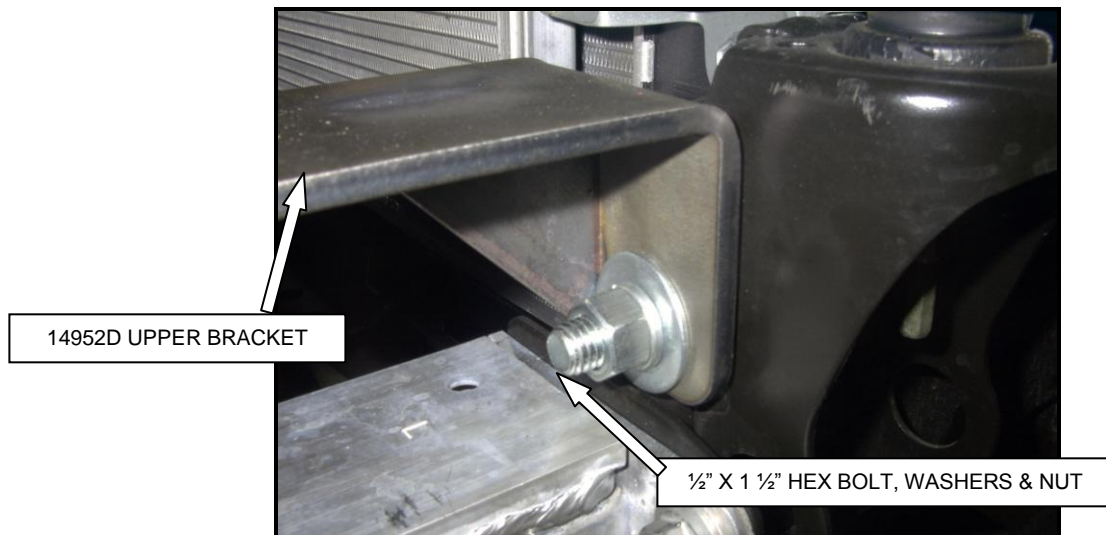

STEP -6 LOOSELY ATTACH 14952D UPPER MOUNTING BRACKET TO THE FRAME USING THE 1/2" X 1 1/2" HEX BOLT, WASHERS, AND NUT. REPEAT THE INSTALLATION FOR THE PASSENGER SIDE UPPER MOUNTING BRACKET.

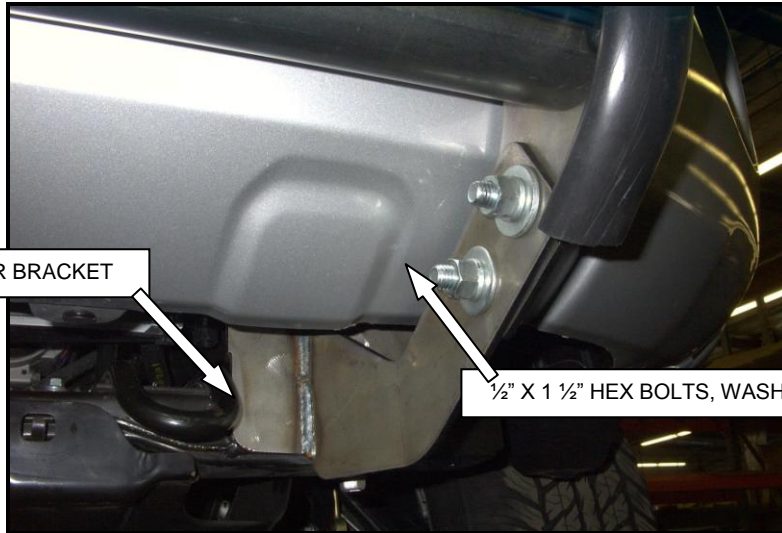

14950D DRIVER SIDE LOWER BRACKET

1/2" X 1 1/2" HEX BOLTS, WASHERS & NUTS

STEP- 7 ATTACH THE GRILLE GUARD ASSEMBLY TO THE OUTSIDE OF THE LOWER MOUNTING BRACKETS USING THE 1/2" X 1 1/2" HEX BOLTS, WASHERS, AND NUTS.

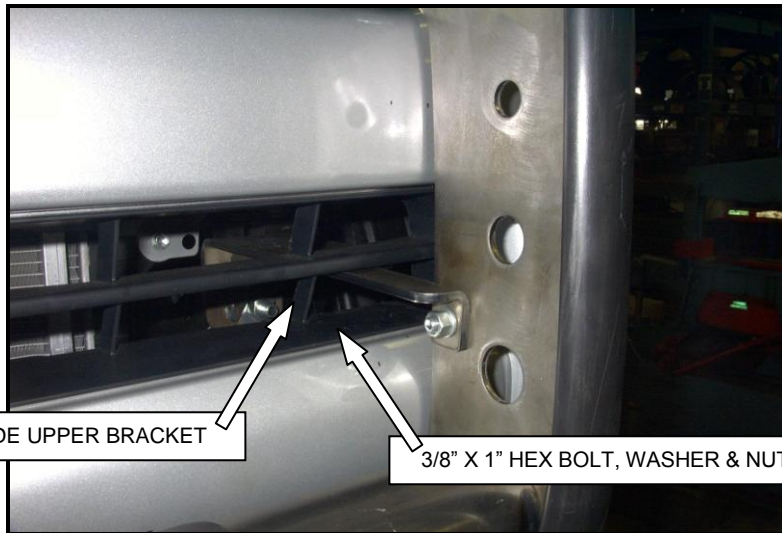

14952D DRIVER SIDE UPPER BRACKET

3/8" X 1" HEX BOLT, WASHER & NUT

STEP- 8 ATTACH THE GRILLE GUARD ASSEMBLY TO THE UPPER MOUNTING BRACKETS USING THE 3/8" X 1" B HEX BOLTS, WASHERS, AND NUTS. ALIGN THE GRILLE GUARD ASSEMBLY WITH THE FRONT OF THE VEHICLE AND TIGHTEN ALL MOUNTING NUTS AND BOLTS.

Review the product package and contents prior to beginning the installation. If you need to place a warranty claim or need assistance, Please contact the Go Rhino customer service team at 1-888-427-4466 during normal business hours Monday thru Friday 7 am to 5 pm PST. You may also email warranty@gorhino.com.