

INSTALLATION INSTRUCTIONS

3000 Series StepGuard 3169(B-C)

2011 Chevrolet Silverado 2500HD, 3500HD P/U 2/4WD Gasoline & Diesel

Do not attempt to install this product on any vehicle other than the one it is designed for and listed above!

Parts List

<u>Qty</u>	<u>Part Description</u>	<u>Qty</u>	<u>Part Description</u>
10	3/8" X 1 1/4" Hex Bolt	2	3169) Side Plate
10	3/8" Lock Washer	1	ST3718) 3" X 37 1/8" Bottom Step Tube
4	3/8" Hex Nut	1	CP3718) 37 1/8" Center Plate
4	3/8" Flat Washer	1	TT3718) 2" X 37 1/8" Top Tube

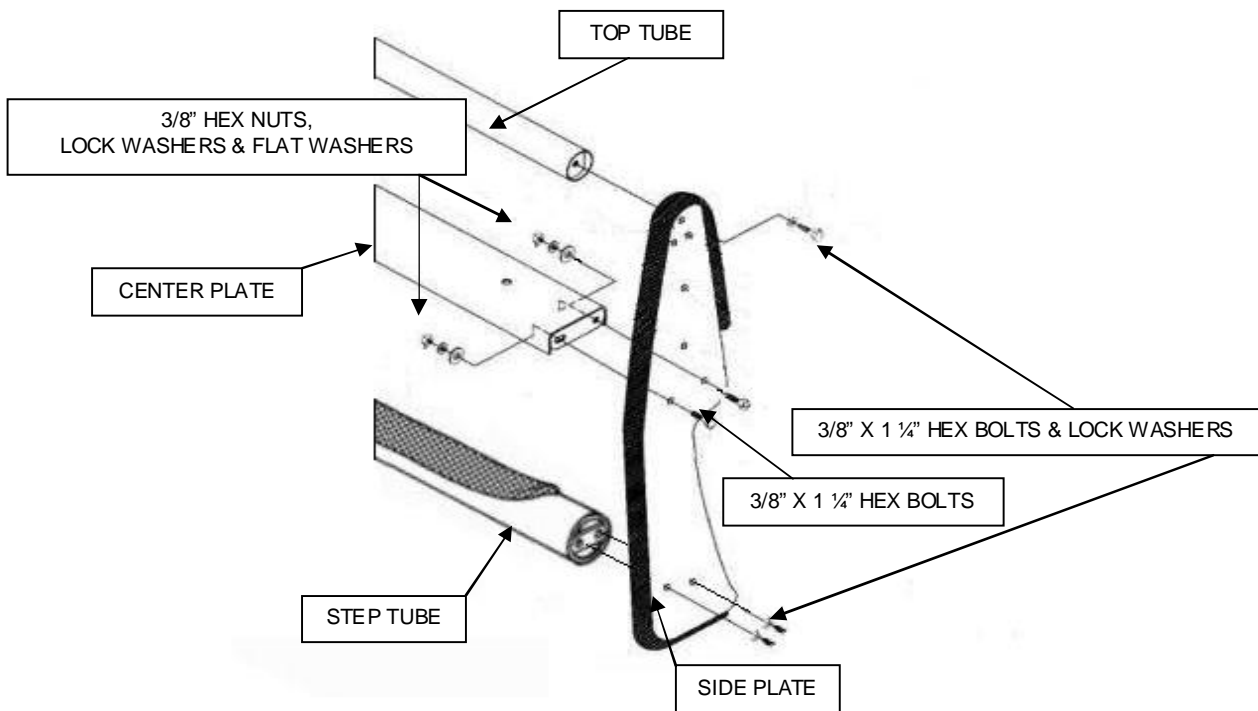

Assembly

Read the assembly and installation instructions completely and verify that all of the parts listed are accounted for.

Step-1 Begin the assembly by laying out the components on a protective surface.

Step-2 Position the side plates front edge down with the top tube, center plate and step tube between the side plates.

Step-3 Attach the top tube and step tube to the side plates using the 3/8" x 1 1/4" hex bolts and 3/8" lock washers.

Step-4 Attach the center plate to the side plates using 3/8" x 1 1/4" hex bolts, 3/8" flat washers, 3/8" lock washers and 3/8" hex nuts.

Step-5 Align the grille guard assembly and tighten all nuts and bolts.

INSTALLATION INSTRUCTIONS

3000 Series StepGuard 3169(B-C)

2011 Chevrolet Silverado 2500HD, 3500HD P/U 2/4WD Gasoline & Diesel

Do not attempt to install this product on any vehicle other than the one it is designed for and listed above!

Parts List

<u>Qty</u>	<u>Part Description</u>	<u>Qty</u>	<u>Part Description</u>
2	3/8" x 1 1/4" Hex Bolt	6	1/2" Flat Washer
2	3/8" Flat Washer	6	1/2" Lock Washer
2	3/8" Lock washer	1	504794AA) Driver Lower Bracket
2	3/8" Hex Nut	1	504794AA) Passenger Lower Bracket
2	1/2" X 1 1/4" Carriage Bolt	1	16911) Driver Upper Bracket
4	1/2" X 1 1/4" Hex Bolt	1	16912) Passenger Upper Bracket
6	1/2" Hex Nut		

Tool Required:

10mm, 18mm & 21mm Wrench & Socket
9/16" & 3/4" Wrench & Socket
Ratchet & Ratchet Extension
Flat Blade Screw Driver & Pliers

Approximate installation time: 45min

Installation

Read the assembly and installation instructions completely and verify that all of the parts listed are accounted for.

Step-1 Beginning with the driver side remove the nuts, bolts and splash shield from the wheel well and lower bumper valance. **Photo #1**

Step-2 Remove the nut, bolts and tow hook from the frame. **Photo #2**

Note: The splash shield and tow hook will be reinstalled.

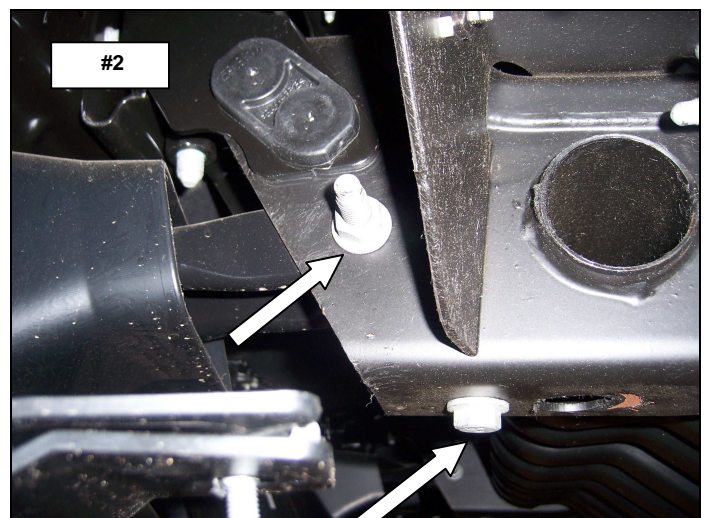
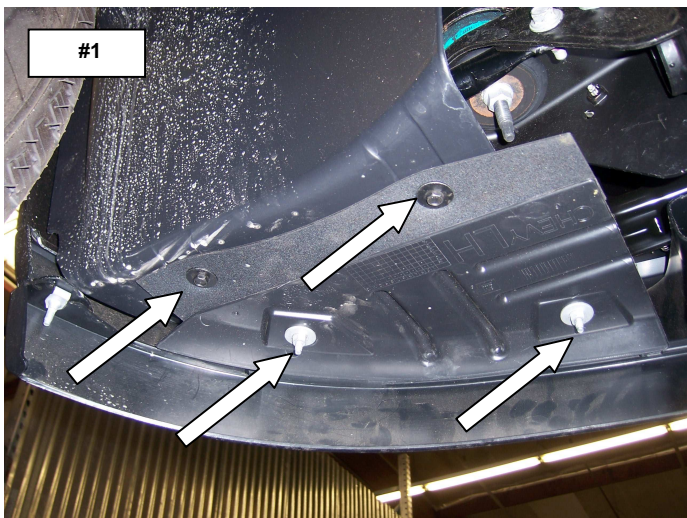

INSTALLATION INSTRUCTIONS

3000 Series StepGuard 3169(B-C)
2011 Chevrolet Silverado 2500HD, 3500HD P/U 2/4WD Gasoline & Diesel

Step-3 From behind the bumper valance, position the driver side lower bracket so the leg of the bracket extends out through the tow hook opening, then rotate and align the bracket with the side and bottom of the frame. **Photo #3 & #4**

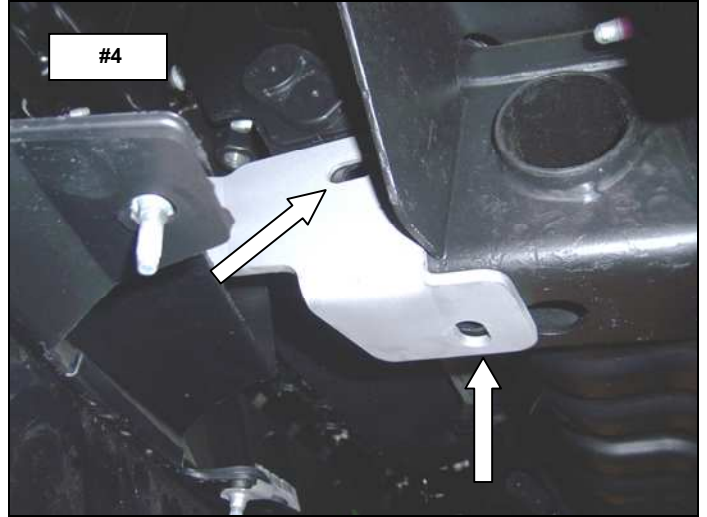
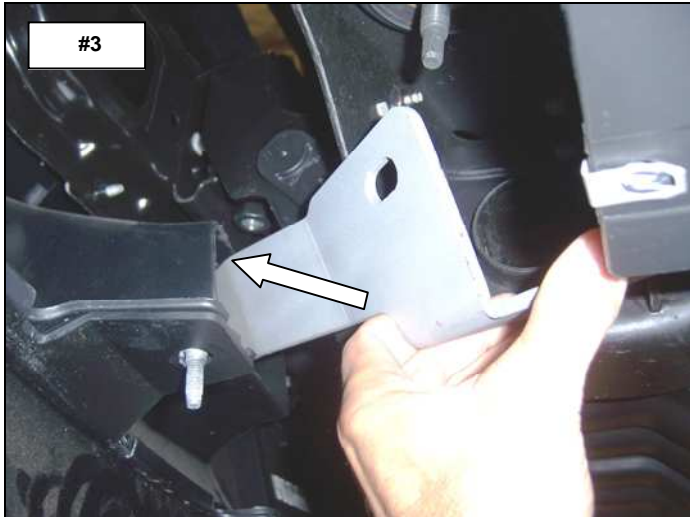

Step-4 position the tow hook inside the frame, align the bracket and tow hook with the holes in the frame and reinstall the tow hook bolts and nut. Leave the tow hook bolts and nut loose for final adjustment.

Photo #5 & #6

Repeat the above steps to install the passenger side lower bracket.

Note: if your vehicle is not equipped with factory tow hooks, attach the lower brackets to the frame using the $\frac{1}{2}$ " x $1 \frac{1}{4}$ " hex bolts, flat washers, lock washers and hex nuts supplied.

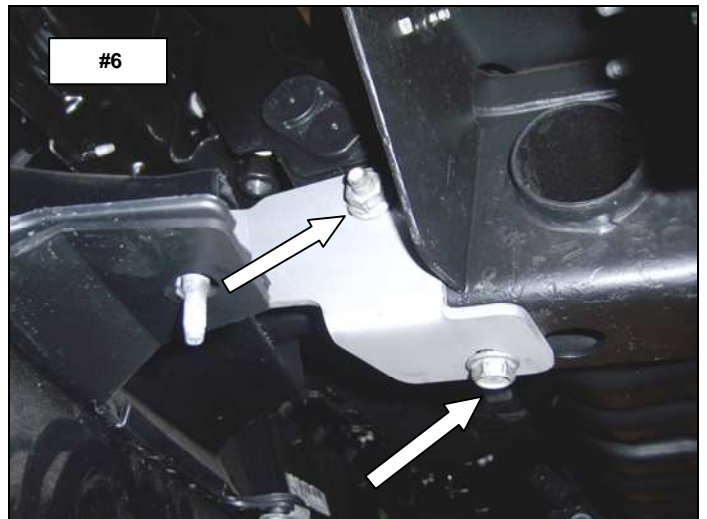

INSTALLATION INSTRUCTIONS

3000 Series StepGuard 3169(B-C)
2011 Chevrolet Silverado 2500HD, 3500HD P/U 2/4WD Gasoline & Diesel

Step-5 Open the hood, locate and remove the plastic rivets and radiator cover. **Photo #7 & #8**

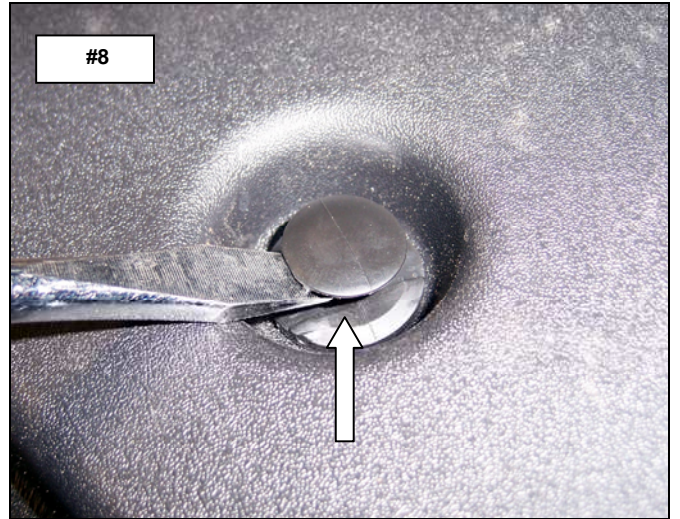
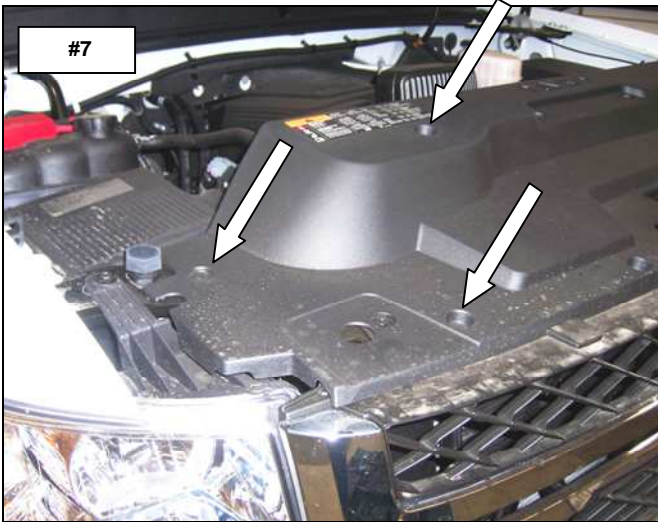

Step-6 Remove the screws securing the top of the grille. **Photo #9**

Step-7 Working from one side use pliers to squeeze the grille mounting clips and gently pull outward to remove the grille. **Photo#10**



INSTALLATION INSTRUCTIONS

3000 Series StepGuard 3169(B-C)
2011 Chevrolet Silverado 2500HD, 3500HD P/U 2/4WD Gasoline & Diesel

Step-8 Remove the bumper bolt from the top of the driver side frame rail. Align the driver side upper bracket with the hole in the frame and reinstall the bumper bolt. Leave the bumper bolt loose for final adjustment. **Photo #11 & #12**

Repeat the above steps to install the passenger side upper bracket.

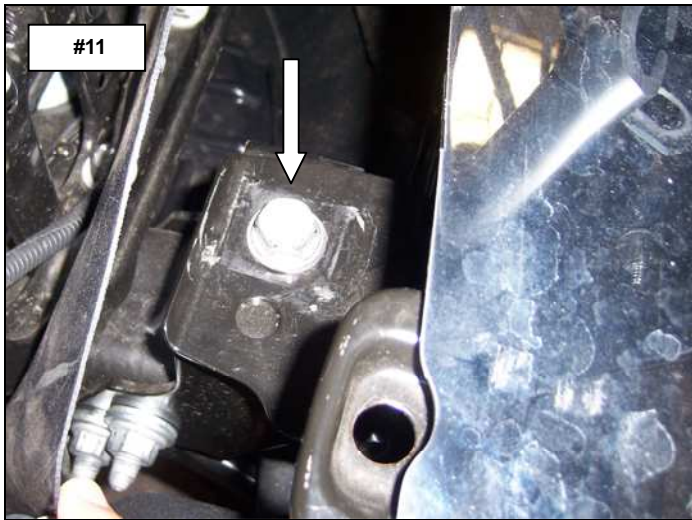

Step-9 Attach the grille guard assembly to the out side of the brackets using the 1/2" x 1 1/4" carriage bolts, 1/2" flat washers, 1/2" lock washers and 1/2" hex nuts for the lower brackets and the 3/8" x 1 1/4" hex bolts, 3/8" flat washers, 3/8" lock washers and 3/8" hex nuts for the upper brackets. Align the grille guard assembly with the vehicle and tighten all nuts and bolts **Photo #13 & Photo #14**

Remember to check and retighten the hardware periodically.

Step-10 Reinstall the vehicle's grille, radiator cover and splash shield.



Please do not return this product to place of purchase.

If you have defective, missing or damaged parts or need assistance, please contact Go Rhino Products for fast, friendly customer service at: 1-800-731-0425 or email: info@gorhino.com